

Standard Finials

Materials and finish

Smith of Derby finials are manufactured from colour impregnated GRP with ultra-violet resistant gel coat. A central M12 threaded stainless steel rod is incorporated to give secure fixing. Optional gilding using 23 1/2 carat double thickness gold leaf is available.

Size and design options

Seven sizes of finial and two sizes of finial ball are available as standard. Larger sizes and special designs can be manufactured to order, and can simulate traditional building materials and textures such as stone or copper.

Lightning conductor options

All finials except the STF15 can incorporate a lightning conductor tip, bonded to the M12 stainless steel rod.

Gilding and colour options

Standard finish is matt or gloss black, (see design range illustration overleaf), with matt grey available to match Smith of Derby turret roofs. Any other BS or RAL colour can be supplied to order. Gold leaf can be applied to the sphere or the entire finial. All finials can be finished with a special copper rich gel coat and be treated to give a verdigris finish.



STF60 finial with optional lightning conductor tip and gold leaf finish



F82 finial in copper verdigris finish fitted to special turret roof



F82 finial in black gloss with optional lightning conductor tip



STF15 finial in matt grey finish to match turret roof

KEY

M = matt finish only

G = gloss finish only

M/G = matt or gloss finish options

Lightning conductor tip available on all models except STF15

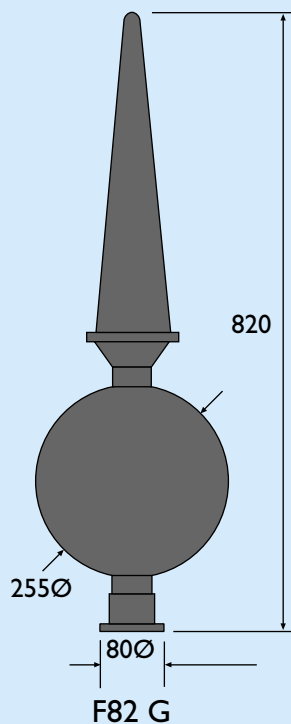
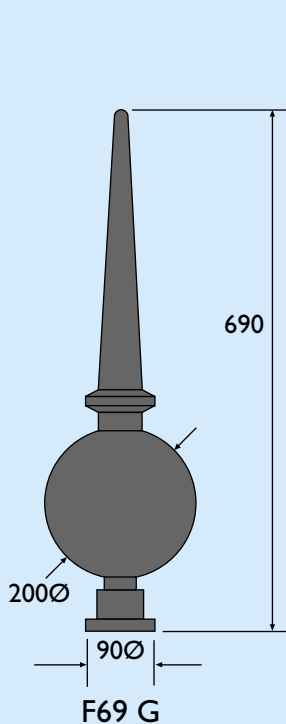
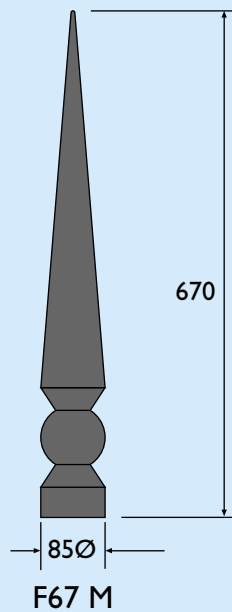
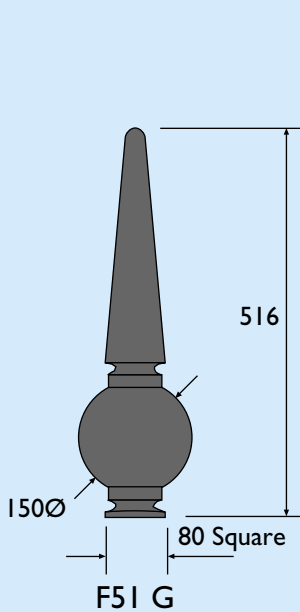
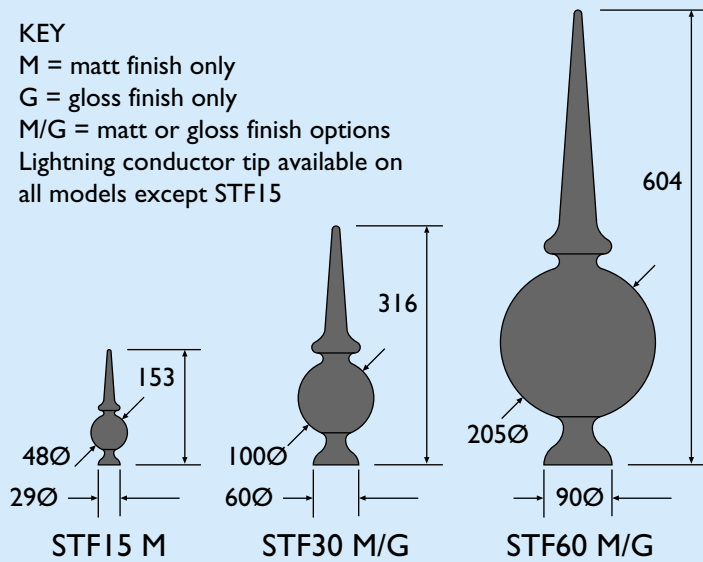

Standard finial range

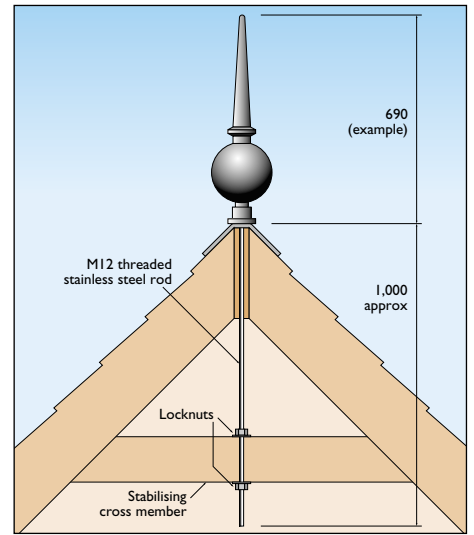

Installation method (F69 shown)

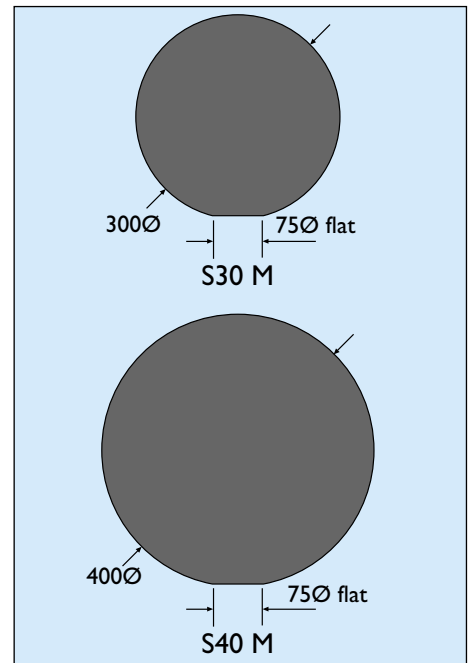

Plain spheres in GRP suitable for roof mounted finial and other applications



www.smithofderby.com

JOHN SMITH & SONS Established 1856

112 Alfreton Road, Derby DE21 4AU UK

Tel: +44 (0)1332 345569 Fax +44 (0)1332 290642

e-mail: sales@smithofderby.com

J B JOYCE & CO Established 1690

Station Road, Whitchurch, Shropshire SY13 1RD

Tel: 01948 662817 Fax 01948 665068

e-mail: sales@jbjoyce.com

WILLIAM POTTS & SONS Established 1833

112 Alfreton Road, Derby DE21 4AU UK

Tel: 01332 345569 Fax 01332 290642

e-mail: sales@pottsofleeds.com

JOHN SMITH & SONS IRELAND

44 Ashleigh Gardens, Skehard Road, Blackrock,

Cork Tel: 021 429 3372 Fax 021 429 1588

e-mail: smithire@gofree.indigo.ie

© Copyright Smith of Derby Ltd 2003. We reserve the right to vary the design, price and specification of our products without prior notice.